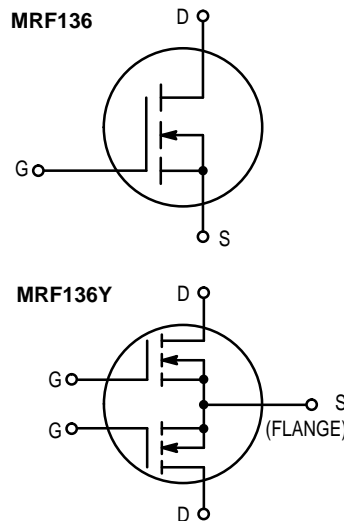


The RF MOSFET Line  
**RF Power**  
**Field-Effect Transistors**  
**N-Channel Enhancement-Mode MOSFETs**

... designed for wideband large-signal amplifier and oscillator applications up to 400 MHz range, in either single ended or push-pull configuration.

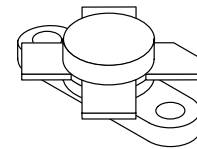
- Guaranteed 28 Volt, 150 MHz Performance  

<b>MRF136</b> Output Power = 15 Watts Narrowband Gain = 16 dB (Typ) Efficiency = 60% (Typical)	<b>MRF136Y</b> Output Power = 30 Watts Broadband Gain = 14 dB (Typ) Efficiency = 54% (Typical)
---	---
- Small-Signal and Large-Signal Characterization
- 100% Tested For Load Mismatch At All Phase Angles With 30:1 VSWR
- Space Saving Package For Push-Pull Circuit Applications — MRF136Y
- Excellent Thermal Stability, Ideally Suited For Class A Operation
- Facilitates Manual Gain Control, ALC and Modulation Techniques

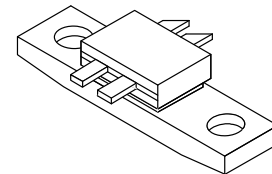


**MRF136**  
**MRF136Y**

15 W, 30 W, to 400 MHz  
N-CHANNEL  
MOS BROADBAND  
RF POWER FETs



CASE 211-07, STYLE 2  
MRF136



CASE 319B-02, STYLE 1  
MRF136Y

**MAXIMUM RATINGS**

Rating	Symbol	Value		Unit
		MRF136	MRF136Y	
Drain-Source Voltage	$V_{DSS}$	65	65	Vdc
Drain-Gate Voltage ( $R_{GS} = 1.0 \text{ M}\Omega$ )	$V_{DGR}$	65	65	Vdc
Gate-Source Voltage	$V_{GS}$	±40		Vdc
Drain Current — Continuous	$I_D$	2.5	5.0	Adc
Total Device Dissipation @ $T_C = 25^\circ\text{C}$ Derate above $25^\circ\text{C}$	$P_D$	55 0.314	100 0.571	Watts W/°C
Storage Temperature Range	$T_{stg}$	-65 to +150		°C
Operating Junction Temperature	$T_J$	200		°C

**THERMAL CHARACTERISTICS**

Characteristic	Symbol	Max		Unit
		MRF136	MRF136Y	
Thermal Resistance, Junction to Case	$R_{\theta JC}$	3.2	1.75	°C/W

**Handling and Packaging** — MOS devices are susceptible to damage from electrostatic charge. Reasonable precautions in handling and packaging MOS devices should be observed.

**ELECTRICAL CHARACTERISTICS** ( $T_C = 25^\circ\text{C}$  unless otherwise noted.)

Characteristic	Symbol	Min	Typ	Max	Unit
----------------	--------	-----	-----	-----	------

**OFF CHARACTERISTICS (1)**

Drain–Source Breakdown Voltage ( $V_{GS} = 0$ , $I_D = 5.0$ mA)	$V_{(BR)DSS}$	65	—	—	Vdc
Zero–Gate Voltage Drain Current ( $V_{DS} = 28$ V, $V_{GS} = 0$ )	$I_{DSS}$	—	—	2.0	mAdc
Gate–Source Leakage Current ( $V_{GS} = 40$ V, $V_{DS} = 0$ )	$I_{GSS}$	—	—	1.0	$\mu\text{Adc}$

**ON CHARACTERISTICS (1)**

Gate Threshold Voltage ( $V_{DS} = 10$ V, $I_D = 25$ mA)	$V_{GS(th)}$	1.0	3.0	6.0	Vdc
Forward Transconductance ( $V_{DS} = 10$ V, $I_D = 250$ mA)	$g_{fs}$	250	400	—	mmhos

**DYNAMIC CHARACTERISTICS (1)**

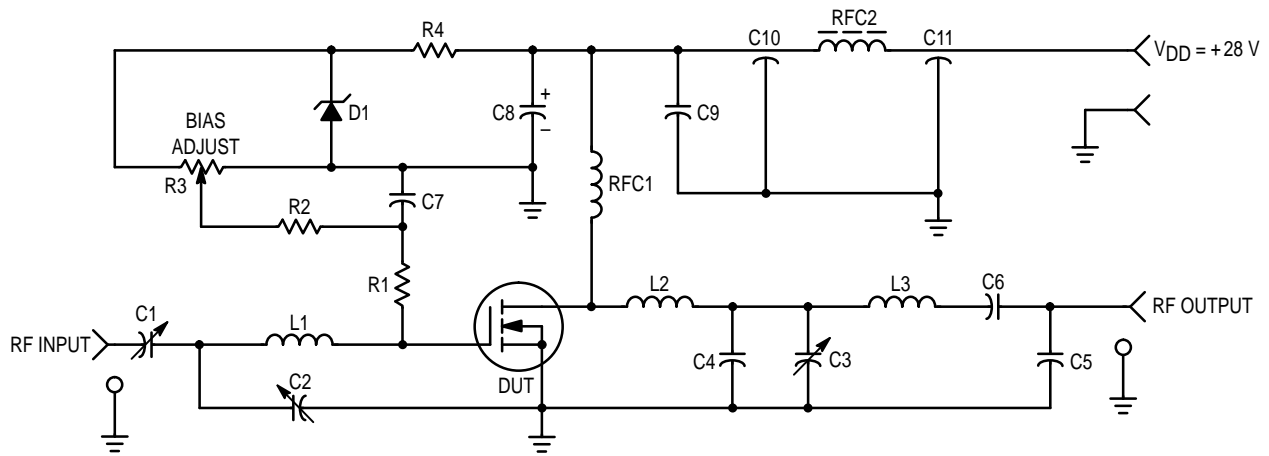
Input Capacitance ( $V_{DS} = 28$ V, $V_{GS} = 0$ , $f = 1.0$ MHz)	$C_{iss}$	—	24	—	pF
Output Capacitance ( $V_{DS} = 28$ V, $V_{GS} = 0$ , $f = 1.0$ MHz)	$C_{oss}$	—	27	—	pF
Reverse Transfer Capacitance ( $V_{DS} = 28$ V, $V_{GS} = 0$ , $f = 1.0$ MHz)	$C_{rss}$	—	5.5	—	pF

**FUNCTIONAL CHARACTERISTICS (2)**

Noise Figure ( $V_{DS} = 28$ Vdc, $I_D = 500$ mA, $f = 150$ MHz)	MRF136	NF	—	1.0	—	dB
Common Source Power Gain (Figure 1) ( $V_{DD} = 28$ Vdc, $P_{out} = 15$ W, $f = 150$ MHz, $I_{DQ} = 25$ mA)	MRF136	$G_{ps}$	13	16	—	dB
Common Source Power Gain (Figure 2) ( $V_{DD} = 28$ Vdc, $P_{out} = 30$ W, $f = 150$ MHz, $I_{DQ} = 100$ mA)	MRF136Y	$G_{ps}$	12	14	—	dB
Drain Efficiency (Figure 1) ( $V_{DD} = 28$ Vdc, $P_{out} = 15$ W, $f = 150$ MHz, $I_{DQ} = 25$ mA)	MRF136	$\eta$	50	60	—	%
Drain Efficiency (Figure 2) ( $V_{DD} = 28$ Vdc, $P_{out} = 30$ W, $f = 150$ MHz, $I_{DQ} = 100$ mA)	MRF136Y	$\eta$	50	54	—	%
Electrical Ruggedness (Figure 1) ( $V_{DD} = 28$ Vdc, $P_{out} = 15$ W, $f = 150$ MHz, $I_{DQ} = 25$ mA, VSWR 30:1 at all Phase Angles)	MRF136	$\psi$	No Degradation in Output Power			
Electrical Ruggedness (Figure 2) ( $V_{DD} = 28$ Vdc, $P_{out} = 30$ W, $f = 150$ MHz, $I_{DQ} = 100$ mA, VSWR 30:1 at all Phase Angles)	MRF136Y	$\psi$	No Degradation in Output Power			

## NOTES:

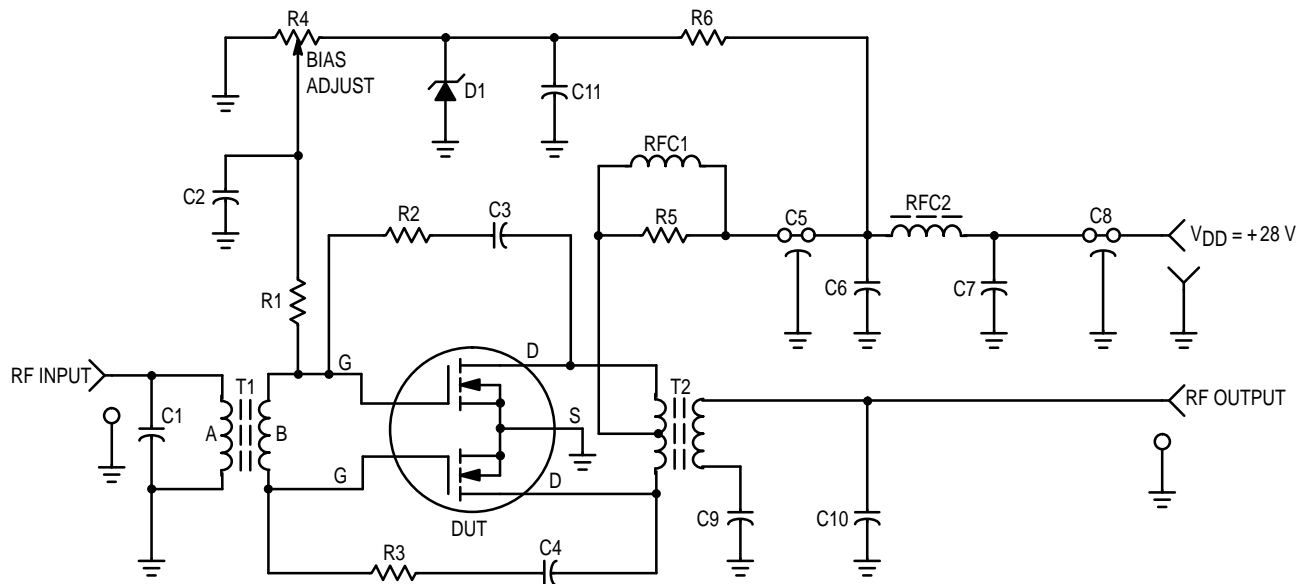
1. For MRF136Y, each side measured separately.
2. For MRF136Y measured in push–pull configuration.



- C1, C2 — Arco 406, 15–115 pF or Equivalent
- C3 — Arco 404, 8–60 pF or Equivalent
- C4 — 43 pF Mini-Unelco or Equivalent
- C5 — 24 pF Mini-Unelco or Equivalent
- C6 — 680 pF, 100 Mils Chip
- C7 — 0.01  $\mu$ F Ceramic
- C8 — 100  $\mu$ F, 40 V
- C9 — 0.1  $\mu$ F Ceramic
- C10, C11 — 680 pF Feedthru
- D1 — 1N5925A Motorola Zener

- L1 — 2 Turns, 0.29" ID, #18 AWG, 0.10" Long
- L2 — 2 Turns, 0.23" ID, #18 AWG, 0.10" Long
- L3 — 2-1/4 Turns, 0.29" ID, #18 AWG, 0.125" Long
- RFC1 — 20 Turns, 0.30" ID, #20 AWG Enamel Closewound
- RFC2 — Ferroxcube VK-200 — 19/4B
- R1 — 27  $\Omega$ , 1 W Thin Film
- R2 — 10 k $\Omega$ , 1/4 W
- R3 — 10 Turns, 10 k $\Omega$
- R4 — 1.8 k $\Omega$ , 1/2 W
- Board Material — 0.062" G10, 1 oz. Cu Clad, Double Sided

**Figure 1. 150 MHz Test Circuit (MRF136)**



- C1 — 5.0 pF
- C2, C3, C4, C6, C7, C9, C11 — 0.1  $\mu$ F Ceramic
- C5, C8 — 680 pF Feedthru
- C10 — 15 pF
- D1 — 1N4740 Motorola Zener
- RFC1 — 17 Turns, #24 AWG Wound on R5
- RFC2 — Ferroxcube VK-200-19/4B or Equivalent
- R1 — 10 k $\Omega$ , 1/4 W
- R2, R3 — 560  $\Omega$ , 1/2 W
- R4 — 10 Turns, 10 k $\Omega$

- R5 — 56 k $\Omega$ , 1 W
- R6 — 1.6 k $\Omega$ , 1/4 W
- T1 — Primary Winding — 3 Turns #28 Enameled Wire.  
— Secondary Winding — 2 Turns #28 Enameled Wire.  
Both windings wound through a Fair/Rite Balun 65 core.  
Part #2865002402.
- T2 — 1:1 Transformer Wound Bifilar — 2 Turns Twisted Pair  
#24 Enameled Wire through a Indiana General Balun Q1  
core. Part #18006-1-Q1. Primary winding center tapped.
- Board Material — 0.062" G10, 1 oz. Cu Clad, Double Sided

**Figure 2. 30–150 MHz Test Circuit (MRF136Y)**

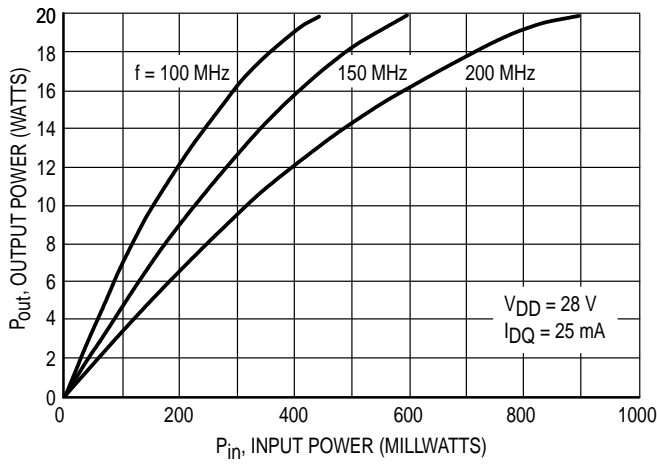


Figure 3. Output Power versus Input Power

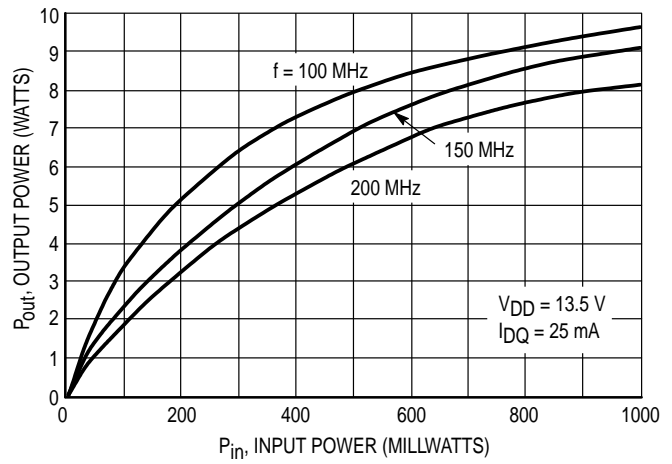


Figure 4. Output Power versus Input Power

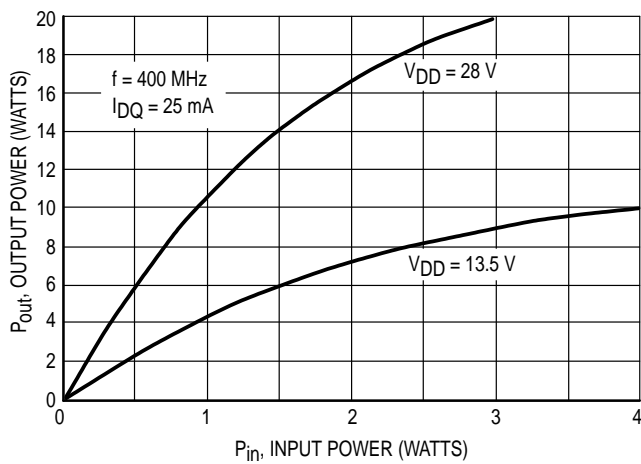


Figure 5. Output Power versus Input Power

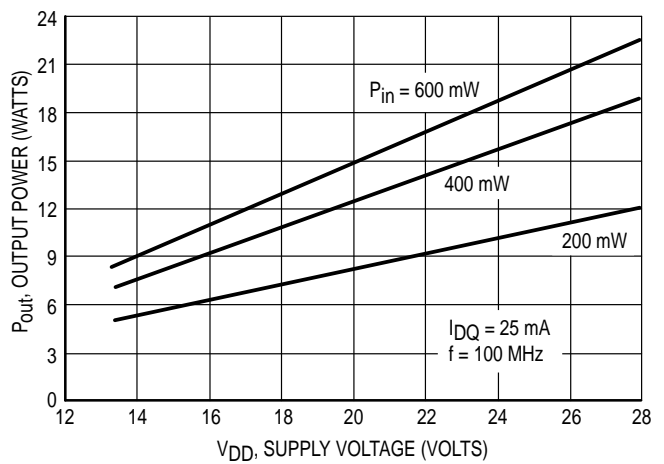


Figure 6. Output Power versus Supply Voltage

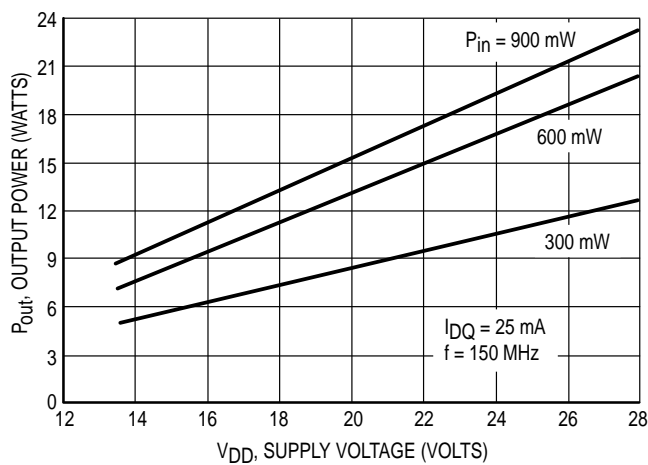


Figure 7. Output Power versus Supply Voltage

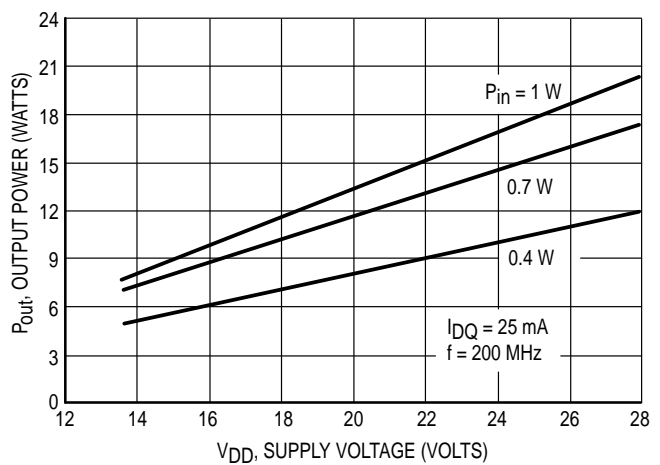
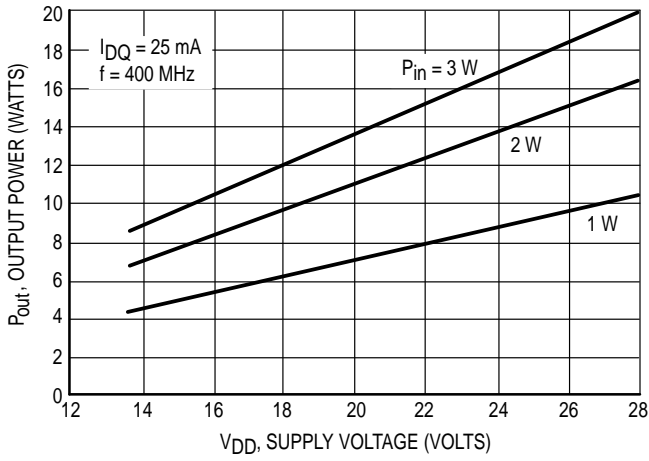
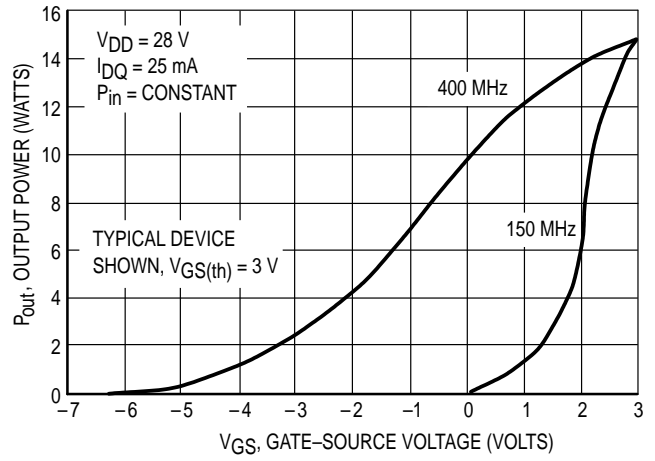


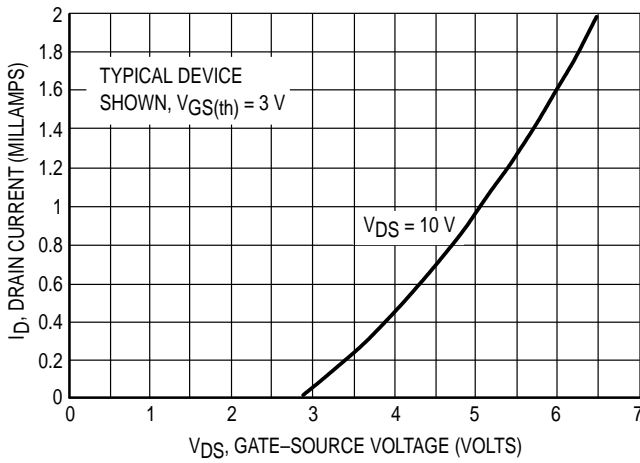
Figure 8. Output Power versus Supply Voltage



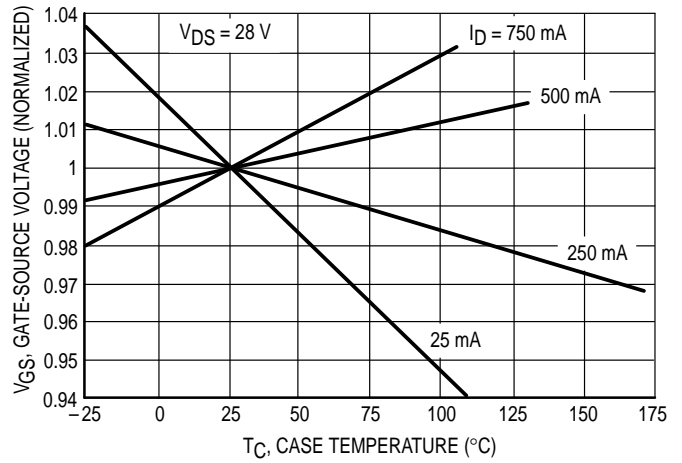
**Figure 9. Output Power versus Supply Voltage  
MRF136**



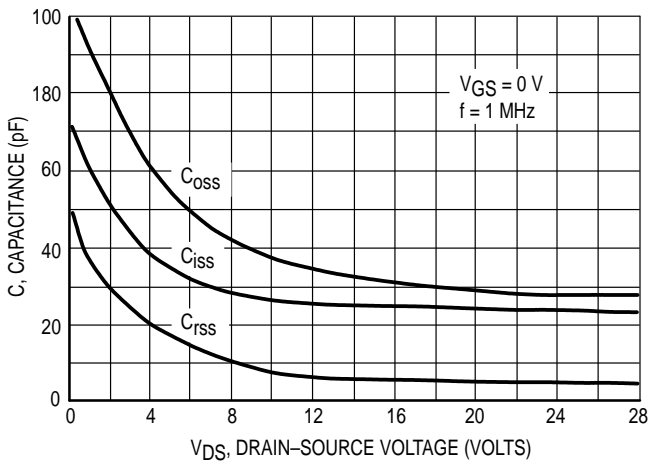
**Figure 10. Output Power versus Gate Voltage  
MRF136**



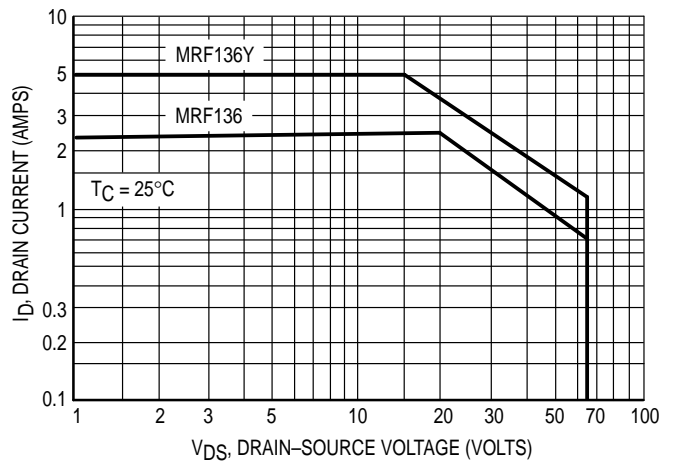
**Figure 11. Drain Current versus Gate Voltage  
(Transfer Characteristics)\*  
MRF136/MRF136Y**



**Figure 12. Gate-Source Voltage versus  
Case Temperature\*  
MRF136/MRF136Y**



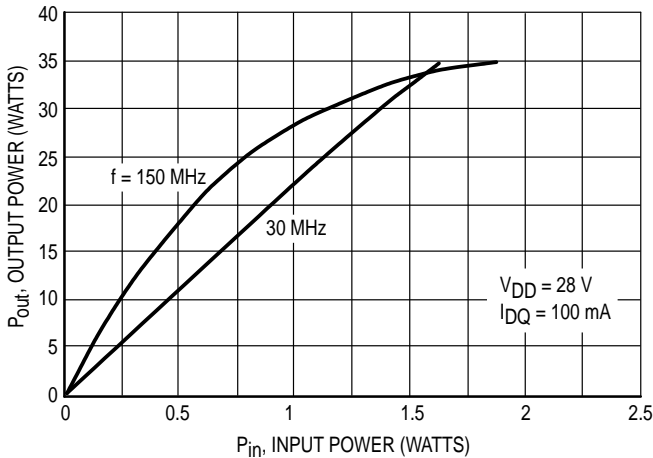
**Figure 13. Capacitance versus Drain-Source Voltage\*  
MRF136/MRF136Y**



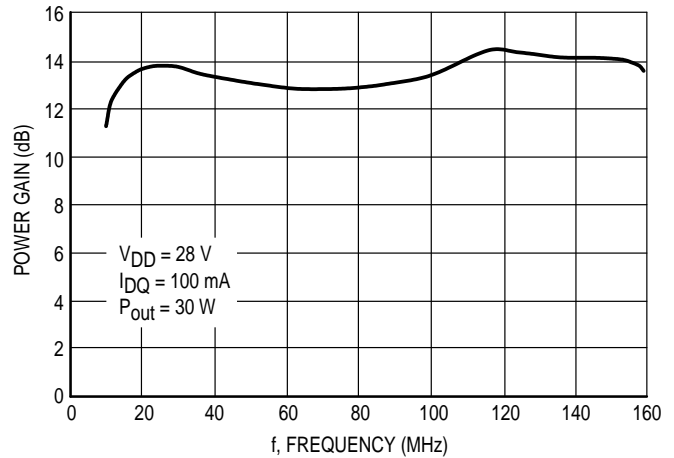
**Figure 14. DC Safe Operating Area  
MRF136/MRF136Y**

\*Data shown applies to MRF136 and each half of MRF136Y.

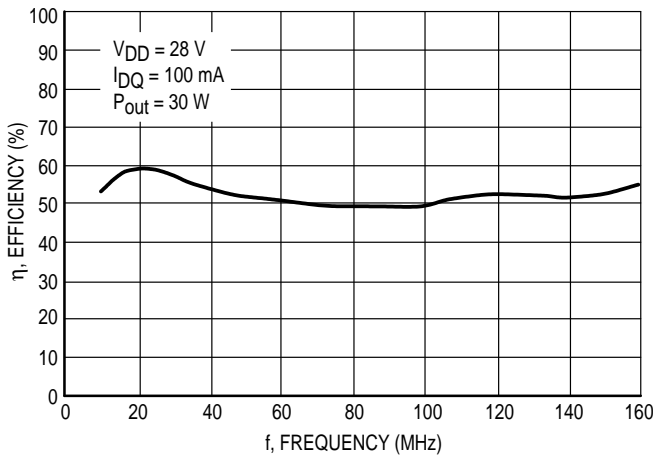
**MRF136Y**  
**TYPICAL PERFORMANCE IN BROADBAND TEST CIRCUIT**  
 (Refer to Figure 2)



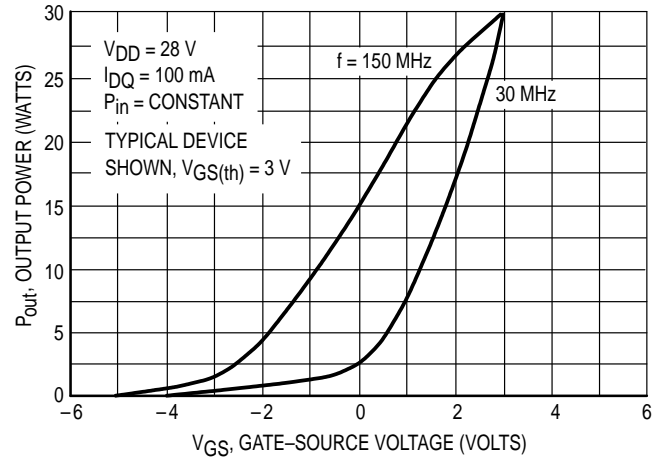
**Figure 15. Output Power versus Input Power**



**Figure 16. Power Gain versus Frequency**

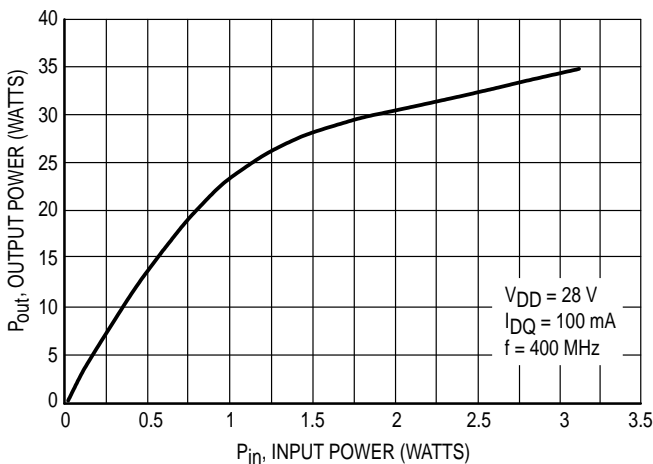


**Figure 17. Drain Efficiency versus Frequency**

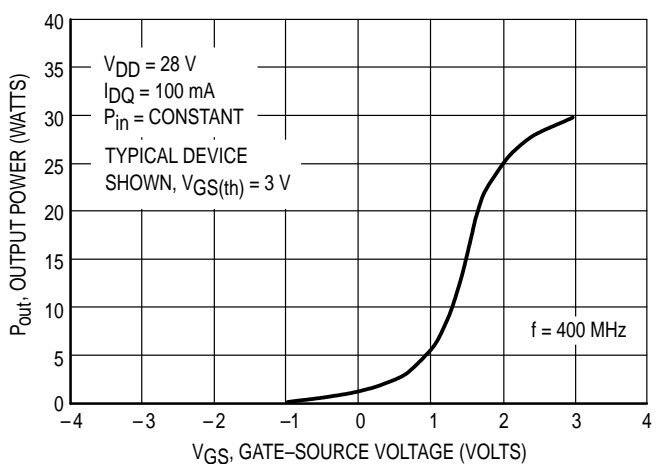


**Figure 18. Output Power versus Gate Voltage**

**TYPICAL 400 MHz PERFORMANCE**



**Figure 19. Output Power versus Input Power**



**Figure 20. Output Power versus Gate Voltage**

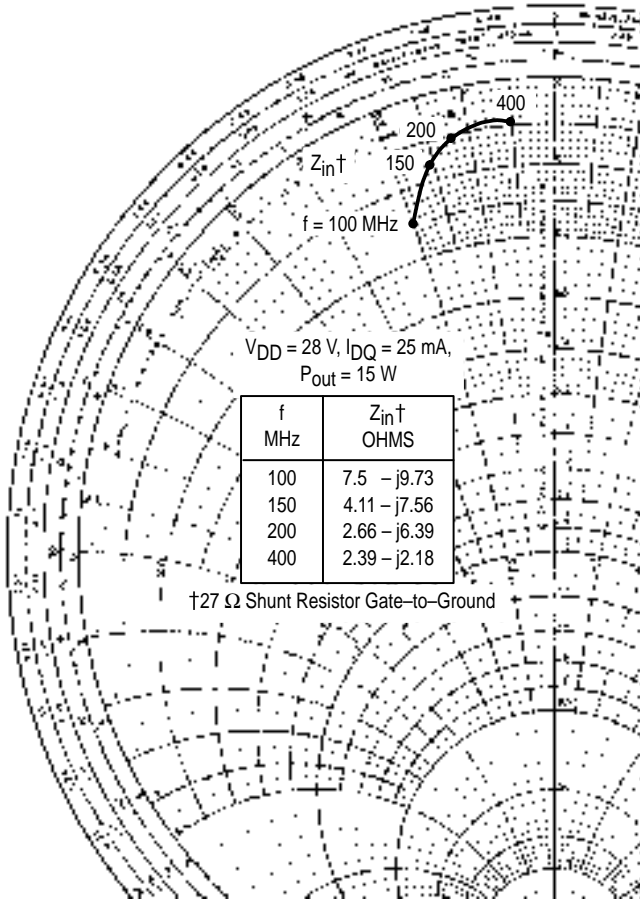


Figure 21. Large-Signal Series Equivalent Input Impedance,  $Z_{in}^\dagger$   
MRF136

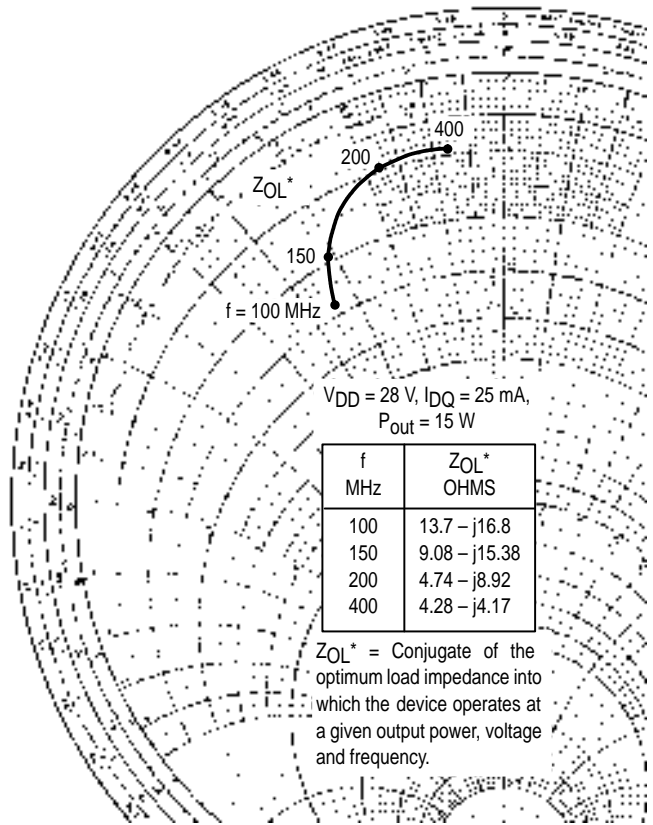


Figure 22. Large-Signal Series Equivalent Output Impedance,  $Z_{OL}^*$   
MRF136

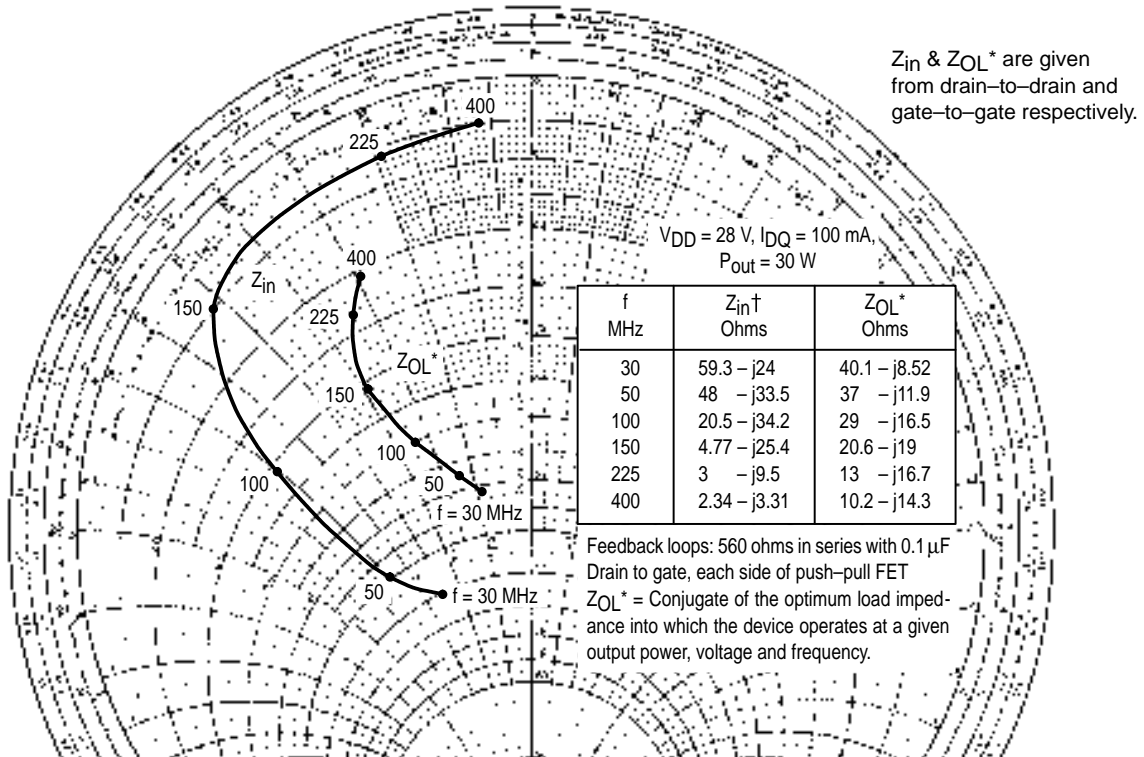


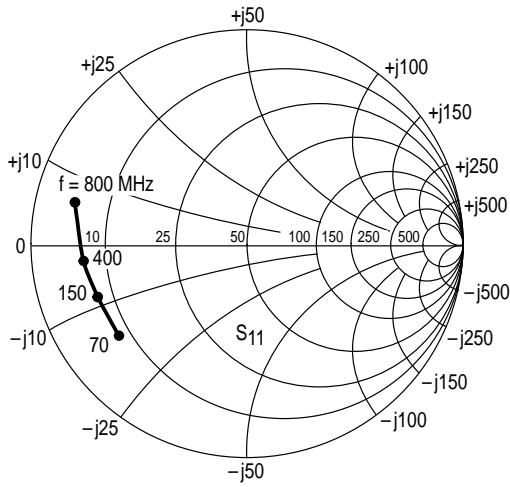
Figure 23. Input and Output Impedance  
MRF136Y

MRF136

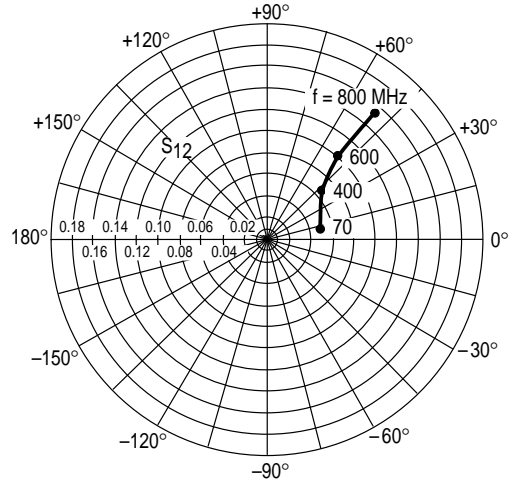
f (MHz)	S <sub>11</sub>		S <sub>21</sub>		S <sub>12</sub>		S <sub>22</sub>	
	S <sub>11</sub>	φ	S <sub>21</sub>	φ	S <sub>12</sub>	φ	S <sub>22</sub>	φ
2.0	0.988	-11	41.19	173	0.006	67	0.729	-12
5.0	0.970	-27	40.07	164	0.014	62	0.720	-31
10	0.923	-52	35.94	149	0.026	54	0.714	-58
20	0.837	-88	27.23	129	0.040	36	0.690	-96
30	0.784	-111	20.75	117	0.046	27	0.684	-118
40	0.751	-125	16.49	108	0.048	22	0.680	-131
50	0.733	-135	13.41	103	0.050	19	0.679	-139
60	0.720	-142	11.43	99	0.050	16	0.678	-145
70	0.709	-147	9.871	96	0.050	14	0.679	-149
80	0.707	-152	8.663	93	0.051	13	0.683	-153
90	0.706	-155	7.784	91	0.051	13	0.682	-155
100	0.708	-157	7.008	88	0.051	13	0.680	-157
110	0.711	-159	6.435	86	0.051	14	0.681	-158
120	0.714	-161	5.899	85	0.051	15	0.682	-159
130	0.717	-163	5.439	82	0.052	16	0.684	-160
140	0.720	-164	5.068	80	0.052	17	0.684	-161
150	0.723	-165	4.709	80	0.052	18	0.686	-161
160	0.727	-166	4.455	78	0.052	18	0.690	-161
170	0.732	-167	4.200	77	0.052	18	0.694	-162
180	0.735	-168	3.967	75	0.052	19	0.699	-162
190	0.738	-169	3.756	74	0.052	19	0.703	-163
200	0.740	-170	3.545	73	0.052	20	0.706	-163
225	0.746	-171	3.140	69	0.053	22	0.717	-163
250	0.742	-172	2.783	67	0.053	25	0.724	-163
275	0.744	-173	2.540	64	0.054	27	0.724	-163
300	0.751	-174	2.323	60	0.055	29	0.736	-163
325	0.757	-175	2.140	58	0.058	32	0.749	-163
350	0.760	-176	1.963	54	0.059	35	0.758	-163
375	0.762	-177	1.838	52	0.062	38	0.768	-163
400	0.774	-179	1.696	50	0.065	41	0.783	-163
425	0.775	-179	1.590	48	0.068	43	0.793	-163
450	0.781	+179	1.493	46	0.071	46	0.805	-163
475	0.787	+177	1.415	43	0.074	47	0.813	-164
500	0.792	+176	1.332	40	0.079	48	0.825	-164
525	0.797	+175	1.259	38	0.083	50	0.831	-164
550	0.801	+175	1.185	37	0.088	51	0.843	-164
575	0.810	+174	1.145	36	0.094	52	0.855	-164
600	0.816	+173	1.091	34	0.101	52	0.869	-165
625	0.818	+171	1.041	32	0.106	53	0.871	-165
650	0.825	+170	0.994	30	0.112	53	0.884	-165
675	0.834	+169	0.962	29	0.119	53	0.890	-165
700	0.837	+168	0.922	27	0.127	53	0.906	-166
725	0.836	+167	0.879	25	0.133	52	0.909	-167
750	0.841	+166	0.838	25	0.140	53	0.917	-167
775	0.844	+165	0.824	24	0.148	52	0.933	-167
800	0.846	+163	0.785	21	0.154	50	0.941	-168

Table 1. Common Source Scattering Parameters  
V<sub>DS</sub> = 28 V, I<sub>D</sub> = 0.5 A

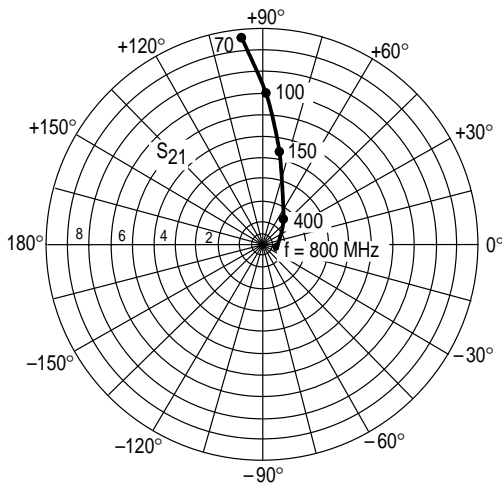




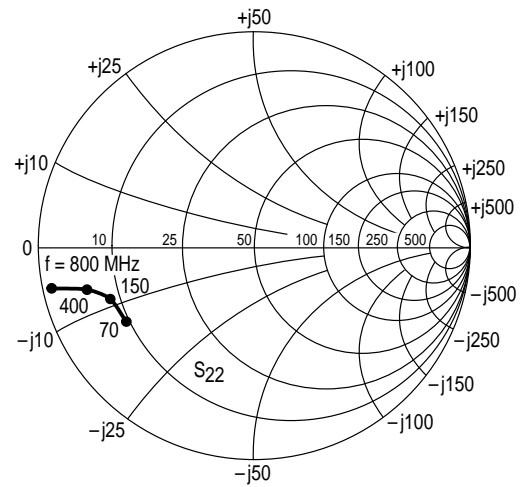
**Figure 24.  $S_{11}$ , Input Reflection Coefficient versus Frequency**  
 $V_{DS} = 28\text{ V}$   $I_D = 0.5\text{ A}$



**Figure 25.  $S_{12}$ , Reverse Transmission Coefficient versus Frequency**  
 $V_{DS} = 28\text{ V}$   $I_D = 0.5\text{ A}$



**Figure 26.  $S_{21}$ , Forward Transmission Coefficient versus Frequency**  
 $V_{DS} = 28\text{ V}$   $I_D = 0.5\text{ A}$



**Figure 27.  $S_{22}$ , Output Reflection Coefficient versus Frequency**  
 $V_{DS} = 28\text{ V}$   $I_D = 0.5\text{ A}$

## DESIGN CONSIDERATIONS

The MRF136 and MRF136Y are RF power N-Channel enhancement mode field-effect transistors (FETs) designed especially for HF and VHF power amplifier applications. Motorola RF MOS FETs feature planar design for optimum manufacturability.

Motorola Application Note AN211A, FETs in Theory and Practice, is suggested reading for those not familiar with the construction and characteristics of FETs.

The major advantages of RF power FETs include high gain, low noise, simple bias systems, relative immunity from thermal runaway, and the ability to withstand severely mismatched loads without suffering damage. Power output can be varied over a wide range with a low power dc control signal, thus facilitating manual gain control, ALC and modulation.

## DC BIAS

The MRF136 and MRF136Y are enhancement mode FETs and, therefore, do not conduct when drain voltage is applied without gate bias. A positive gate voltage causes drain current to flow (see Figure 11). RF power FETs require forward bias for optimum gain and power output. A Class AB condition with quiescent drain current ( $I_{DQ}$ ) in the 25–100 mA range is sufficient for many applications. For special requirements such as linear amplification,  $I_{DQ}$  may have to be adjusted to optimize the critical parameters.

The MOS gate is a dc open circuit. Since the gate bias circuit does not have to deliver any current to the FET, a simple resistive divider arrangement may sometimes suffice for this function. Special applications may require more elaborate gate bias systems.

## GAIN CONTROL

Power output of the MRF136 and MRF136Y may be controlled from rated values down to the milliwatt region (>20 dB reduction in power output with constant input power) by varying the dc gate voltage. This feature, not available in

bipolar RF power devices, facilitates the incorporation of manual gain control, AGC/ALC and modulation schemes into system designs. A full range of power output control may require dc gate voltage excursions into the negative region.

## AMPLIFIER DESIGN

Impedance matching networks similar to those used with bipolar transistors are suitable for MRF136 and MRF136Y. See Motorola Application Note AN721, Impedance Matching Networks Applied to RF Power Transistors. Both small signal scattering parameters (MRF136 only) and large signal impedance parameters are provided. Large signal impedances should be used for network designs wherever possible. While the s parameters will not produce an exact design solution for high power operation, they do yield a good first approximation. This is particularly useful at frequencies outside those presented in the large signal impedance plots.

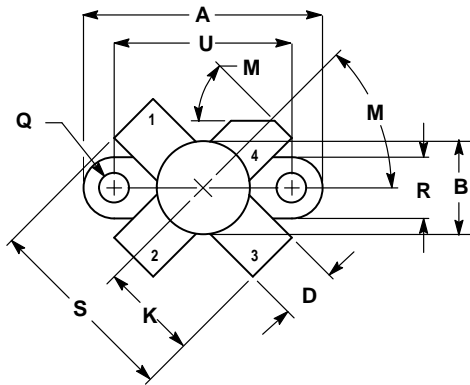
RF power FETs are triode devices and are therefore not unilateral. This, coupled with the very high gain, yields a device capable of self oscillation. Stability may be achieved using techniques such as drain loading, input shunt resistive loading, or feedback. S parameter stability analysis can provide useful information in the selection of loading and/or feedback to insure stable operation. The MRF136 was characterized with a 27 ohm input shunt loading resistor, while the MRF136Y was characterized with a resistive feedback loop around each of its two active devices.

For further discussion of RF amplifier stability and the use of two port parameters in RF amplifier design, see Motorola Application Note AN215A on page 6–204 in the RF Device Data (DL110 Rev 1).

## LOW NOISE OPERATION

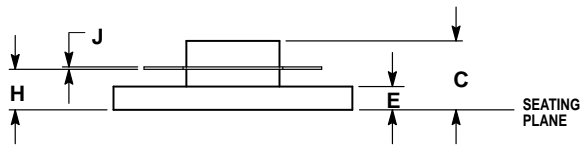
Input resistive loading will degrade noise performance, and noise figure may vary significantly with gate driving impedance. A low loss input matching network with its gate impedance optimized for lowest noise is recommended.

## PACKAGE DIMENSIONS



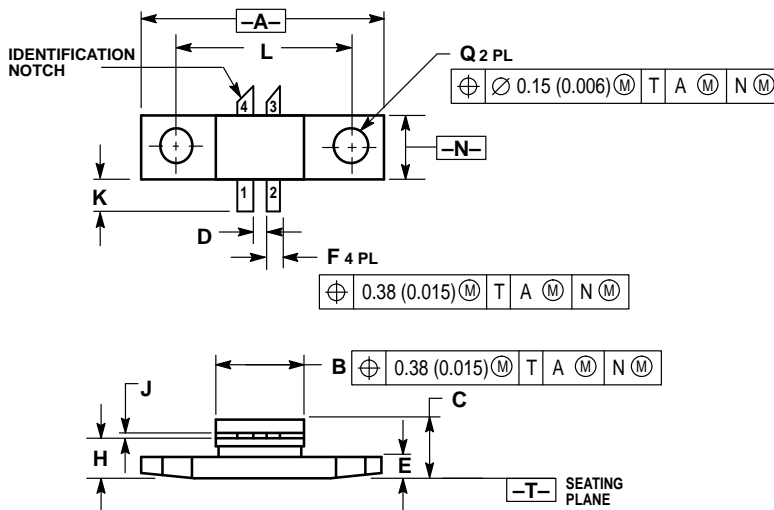
- NOTES:  
 1. DIMENSIONING AND TOLERANCING PER ANSI Y14.5M, 1982.  
 2. CONTROLLING DIMENSION: INCH.

DIM	INCHES		MILLIMETERS	
	MIN	MAX	MIN	MAX
A	0.960	0.990	24.39	25.14
B	0.370	0.390	9.40	9.90
C	0.229	0.281	5.82	7.13
D	0.215	0.235	5.47	5.96
E	0.085	0.105	2.16	2.66
H	0.150	0.108	3.81	4.57
J	0.004	0.006	0.11	0.15
K	0.395	0.405	10.04	10.28
M	40°	50°	40°	50°
Q	0.113	0.130	2.88	3.30
R	0.245	0.255	6.23	6.47
S	0.790	0.810	20.07	20.57
U	0.720	0.730	18.29	18.54



- STYLE 2:  
 PIN 1. SOURCE  
 2. GATE  
 3. SOURCE  
 4. DRAIN

**CASE 211-07  
 ISSUE N  
 MRF136**




- NOTES:  
 1. DIMENSIONING AND TOLERANCING PER ANSI Y14.5M, 1982.  
 2. CONTROLLING DIMENSION: INCH.

DIM	INCHES		MILLIMETERS	
	MIN	MAX	MIN	MAX
A	0.965	0.985	24.51	25.02
B	0.355	0.375	9.02	9.52
C	0.230	0.260	5.84	6.60
D	0.055	0.065	1.40	1.65
E	0.102	0.114	2.59	2.90
F	0.055	0.065	1.40	1.65
H	0.160	0.170	4.06	4.31
J	0.004	0.006	0.10	0.15
K	0.120	0.140	3.05	3.55
L	0.725	BSC	18.42	BSC
N	0.225	0.241	5.72	6.12
Q	0.125	0.135	3.18	3.42

- STYLE 1:  
 PIN 1. GATE (INPUT)  
 2. GATE (INPUT)  
 3. DRAIN (OUTPUT)  
 4. DRAIN (OUTPUT)  
 SOURCE IS FLANGE

**CASE 319B-02  
 ISSUE C  
 MRF136Y**

Motorola reserves the right to make changes without further notice to any products herein. Motorola makes no warranty, representation or guarantee regarding the suitability of its products for any particular purpose, nor does Motorola assume any liability arising out of the application or use of any product or circuit, and specifically disclaims any and all liability, including without limitation consequential or incidental damages. "Typical" parameters can and do vary in different applications. All operating parameters, including "Typicals" must be validated for each customer application by customer's technical experts. Motorola does not convey any license under its patent rights nor the rights of others. Motorola products are not designed, intended, or authorized for use as components in systems intended for surgical implant into the body, or other applications intended to support or sustain life, or for any other application in which the failure of the Motorola product could create a situation where personal injury or death may occur. Should Buyer purchase or use Motorola products for any such unintended or unauthorized application, Buyer shall indemnify and hold Motorola and its officers, employees, subsidiaries, affiliates, and distributors harmless against all claims, costs, damages, and expenses, and reasonable attorney fees arising out of, directly or indirectly, any claim of personal injury or death associated with such unintended or unauthorized use, even if such claim alleges that Motorola was negligent regarding the design or manufacture of the part. Motorola and  are registered trademarks of Motorola, Inc. Motorola, Inc. is an Equal Opportunity/Affirmative Action Employer.

**Literature Distribution Centers:**

USA: Motorola Literature Distribution; P.O. Box 20912; Phoenix, Arizona 85036.

EUROPE: Motorola Ltd.; European Literature Centre; 88 Tanners Drive, Blakelands, Milton Keynes, MK14 5BP, England.

JAPAN: Nippon Motorola Ltd.; 4-32-1, Nishi-Gotanda, Shinagawa-ku, Tokyo 141, Japan.

ASIA PACIFIC: Motorola Semiconductors H.K. Ltd.; Silicon Harbour Center, No. 2 Dai King Street, Tai Po Industrial Estate, Tai Po, N.T., Hong Kong.



MRF136/D

